

SHCP 2x5512

3550 -3700 MHz Dual (2x) CP log-periodic antenna

Features

- ❑ Transmit Diversity Gain
- ❑ Can be configured to combine space & polarization diversity
- ❑ Outstanding performance over the entire band (3550 - 3700 MHz)
- ❑ Excellent Axial Ratio
- ❑ Optimized for 4G & 3G systems
- ❑ Low intermodulation
- ❑ Improved Side-to-side rejection
- ❑ Fading reduction
- ❑ Excellent isolation between ports

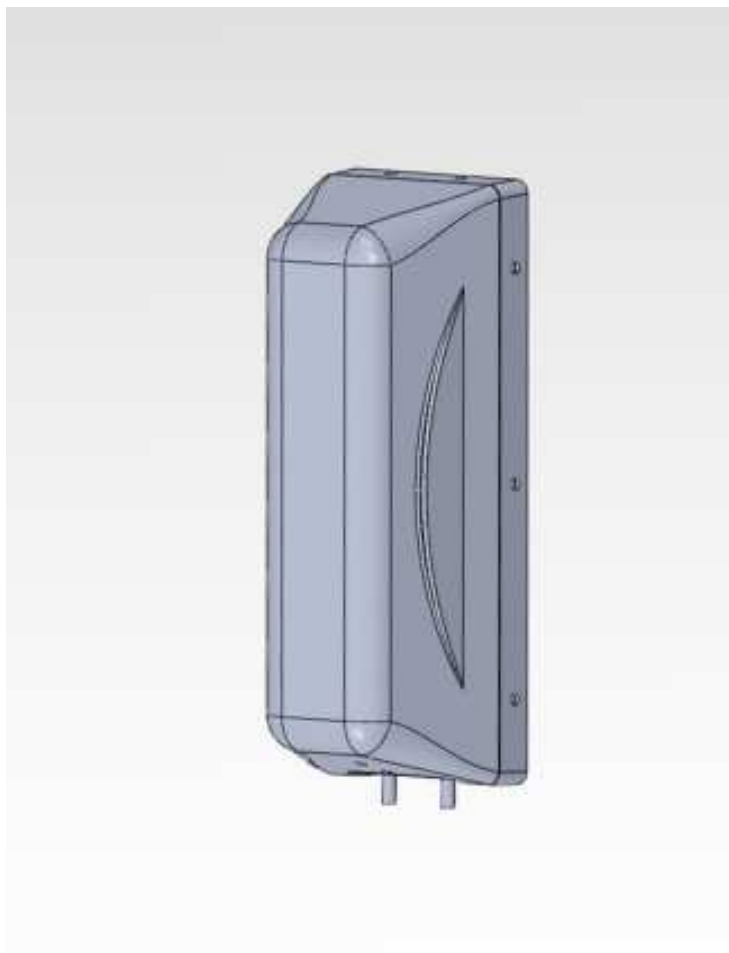

Electrical specifications

Frequency range:	3550 - 3700 MHz
Impedance:	50 ohm
Connector type:	N or SMA
Return loss:	18 dB
Polarization:	Circular
Gain ea. port [Circular]:	2x12 dBdC
Gain ea. port [Linear]:	2x9 dBdL
Axial Ratio:	2 dB
Isolation between ports (TX band):	28 dB
Front-to-back ratio:	30 dB
Intermodulation (2x20W):	IM3 153 dB
	IM5 160 dB
	IM7/9 170 dB
Power rating:	2x 150 W
H-plane (-3 dB point):	2x 55°
V-plane (-3 dB point):	2x 17°
Lightning protection:	DC grounded

Mechanical specifications

Overall height:	11.3 in	[286 mm]
Width:	4.2 in	[107 mm]
Depth:	3.8 in	[97 mm]
Weight (excluding brackets):	5 lbs	[2.3 Kg]
Wind load measured up to:	150 mph	[240 Km/h]
Wind area (front of antenna):	0.33 sq. ft.	[0.030 sq.m]
Lateral thrust at 113 mph/ 180 Km/h (worst case):	17 lbs	[75 N]

Materials

Radiating Elements:	Silver plated brass
Transformer (Power distribution)	Ceramic PCB
Chassis:	Aluminum
Radome:	PVC / TPO
Mounting:	

The SHCP 2x5512 is made in the U.S.A.